

Richard James | Harrys London

Store Design

Charlie McGuinness December 2023

Interior materials

Colours and textures

- Concrete and clay with colour pigment - Canvas and recycled cloth
- Polished plaster
- Travertine
- Brass, Steel and Aluminium
- South American raw dark hardwoods - mahogany etc
- British crafted timber furniture
- Rich colours - Earthy pinks and oxides with soft naturals and grey greens

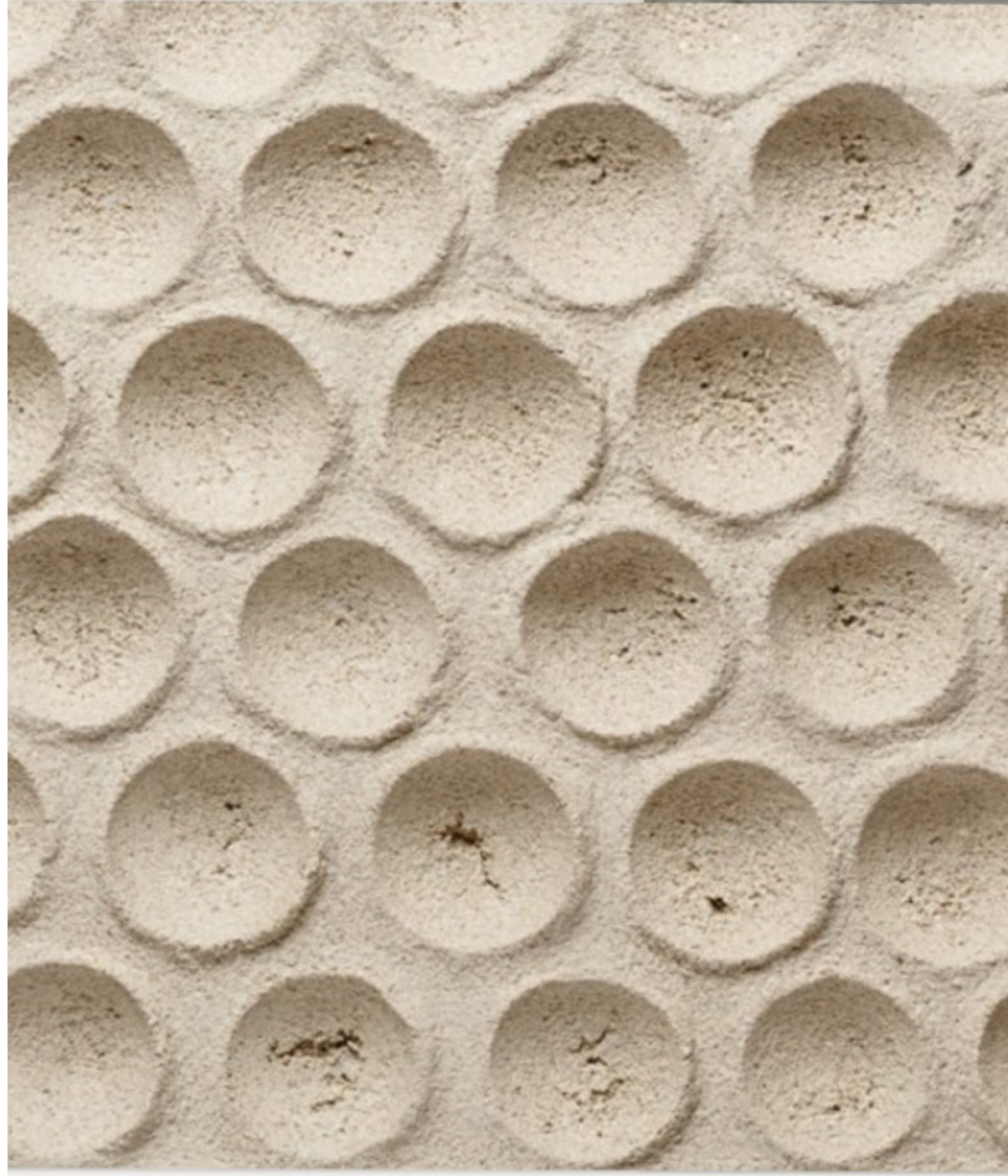





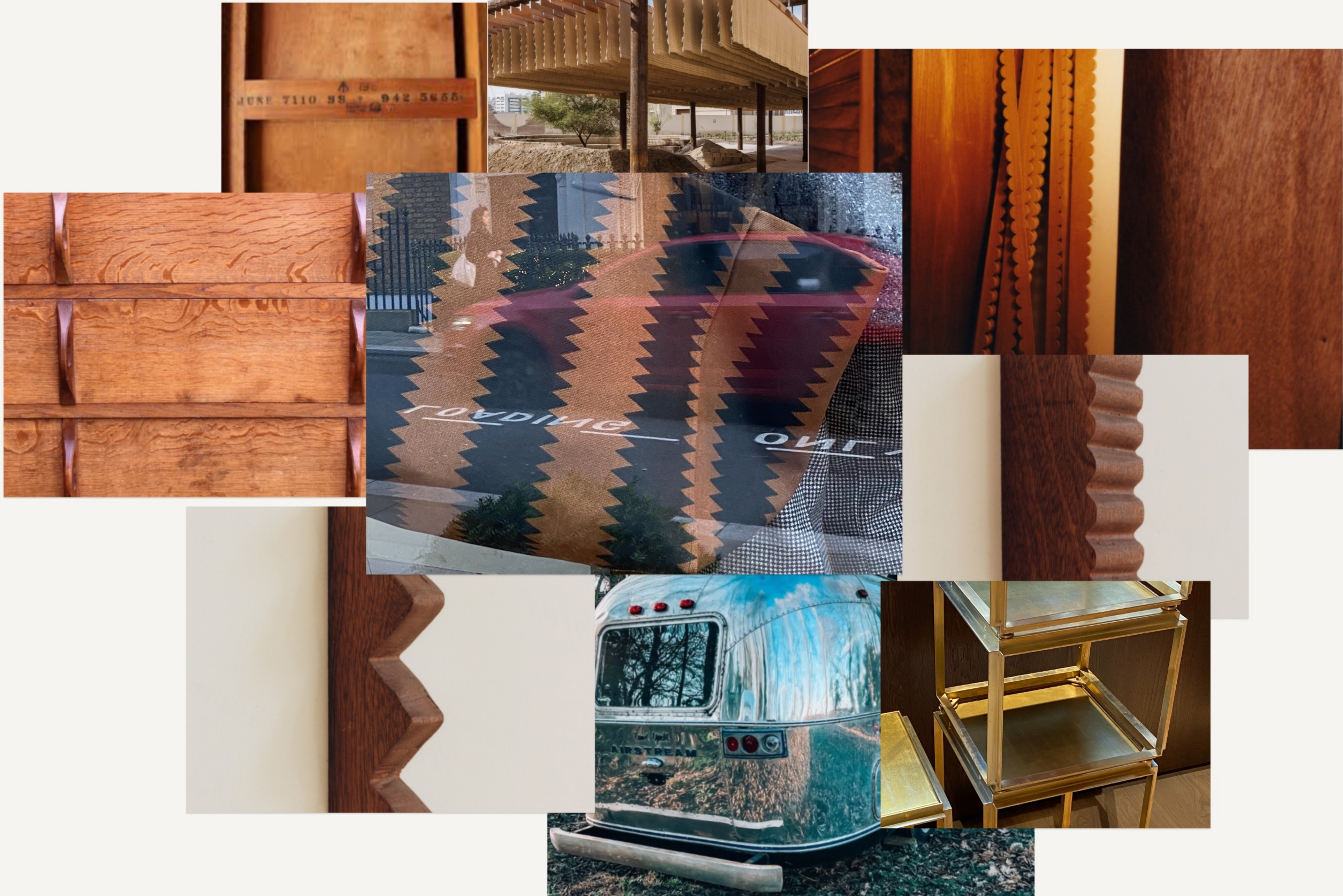

Reception Area

Dual brand entrance space with Reception Cash desk, seating and luxe vitrines to introduce Richard James and Harrys London products.

LOBBY | RECEPTION | CASH
DESK

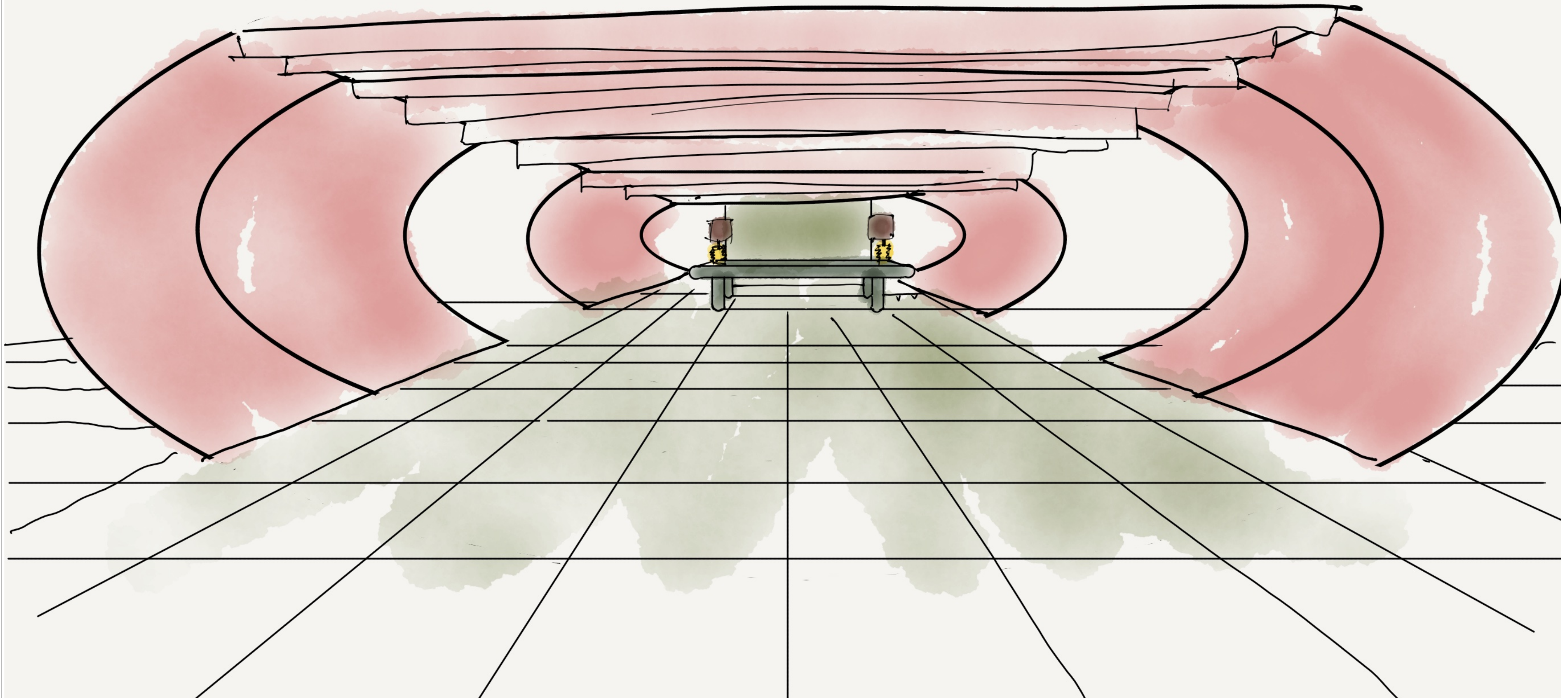

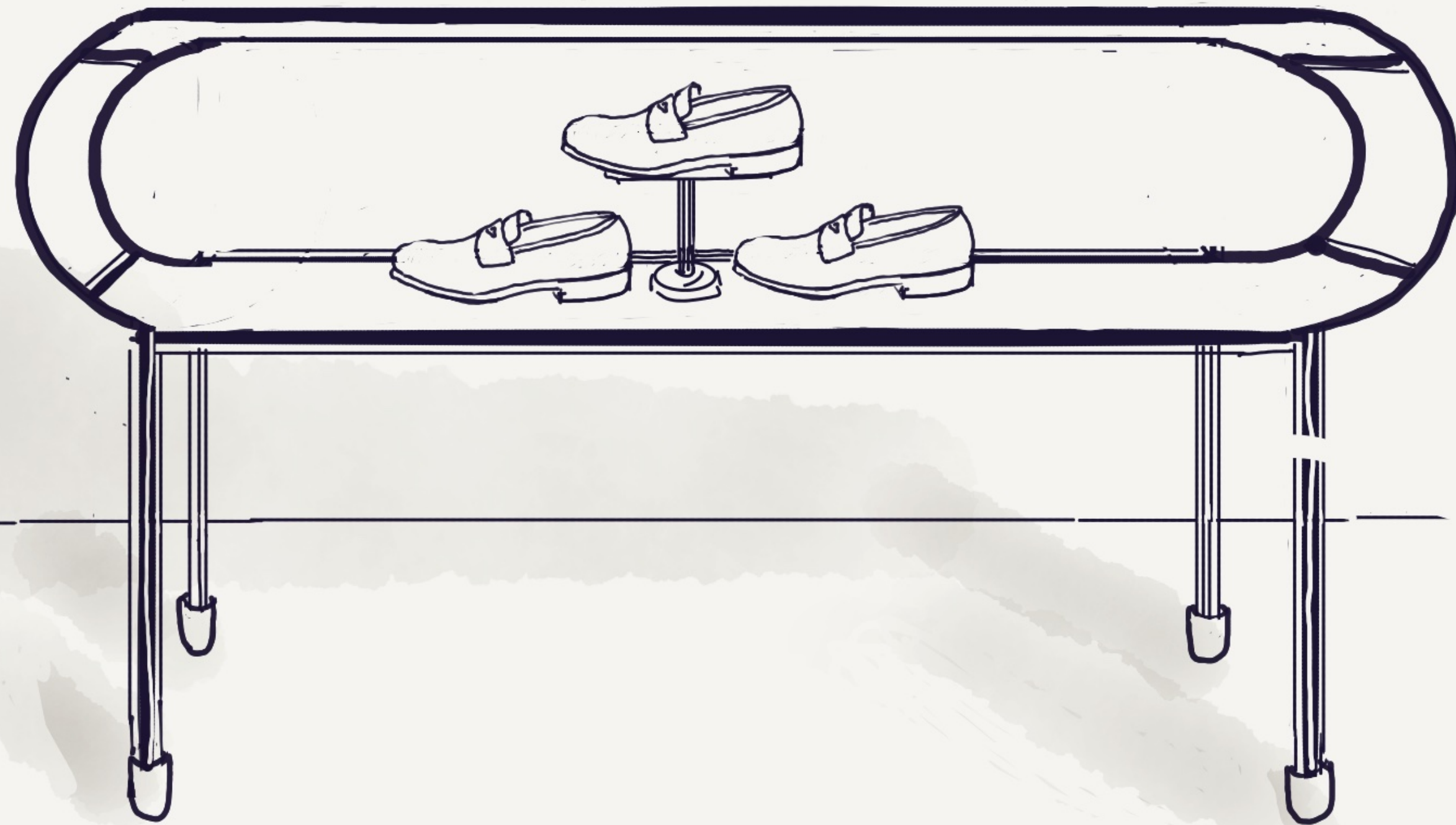

Layout Plan

Richard James and Harrys London

- Dual brand space leading to RJ and HL
- HL area with multi use showroom | Closed off facility - Pocket doors
- HL Shop floor with flexible/movable units and fixtures
- RJ soft zone - Seating with changing rooms and mirror
- RJ Shop floor with flexible and movable units and fixtures - plus large layout table
- Flexible Display zones - rails and new design mannequins

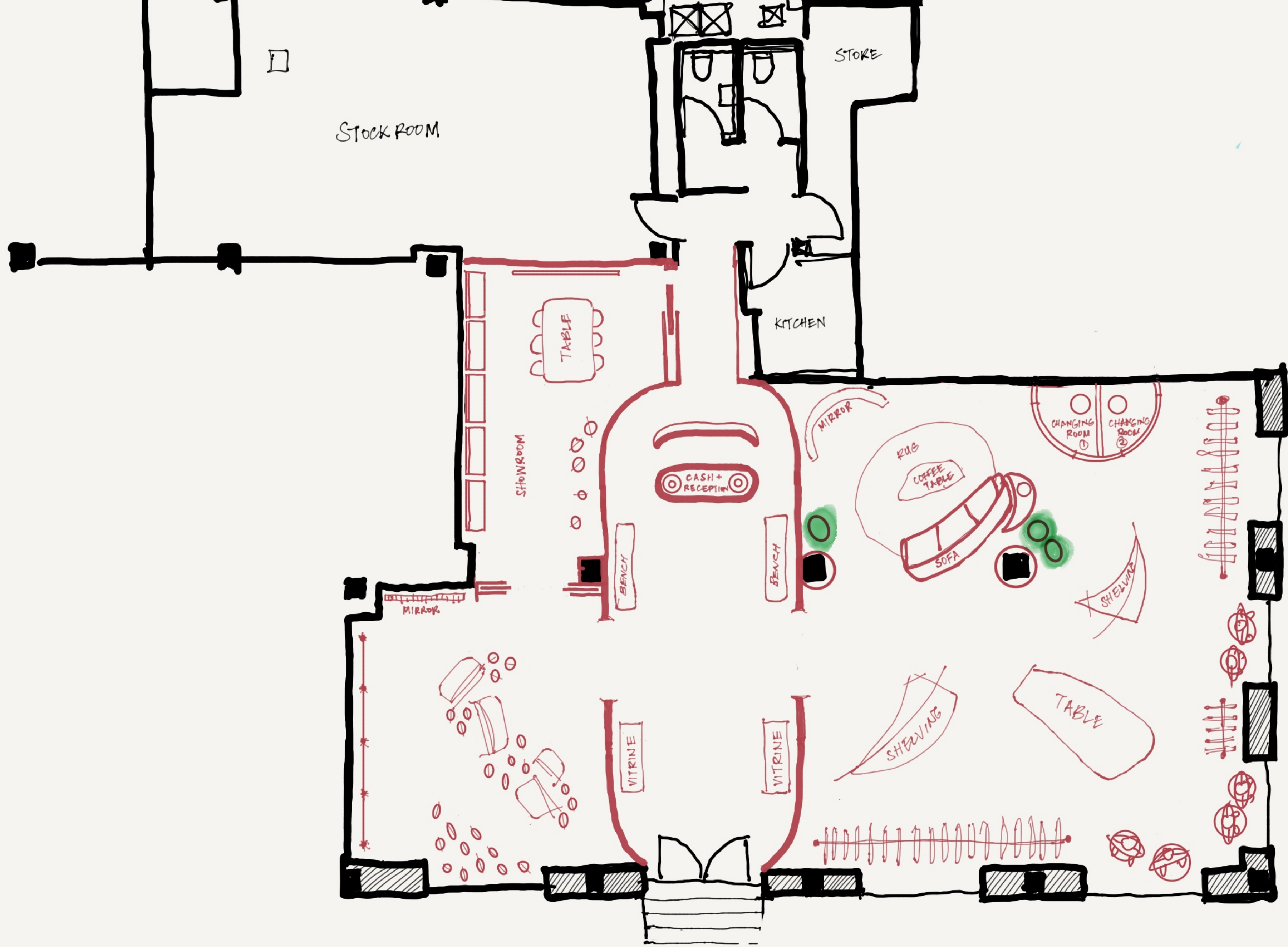

Feature Wall treatment

Large clay tiles

- Colour pigment concrete and canvas
- Reused suiting cloth
- Organic and geometric shapes
- Additional travertine wall areas



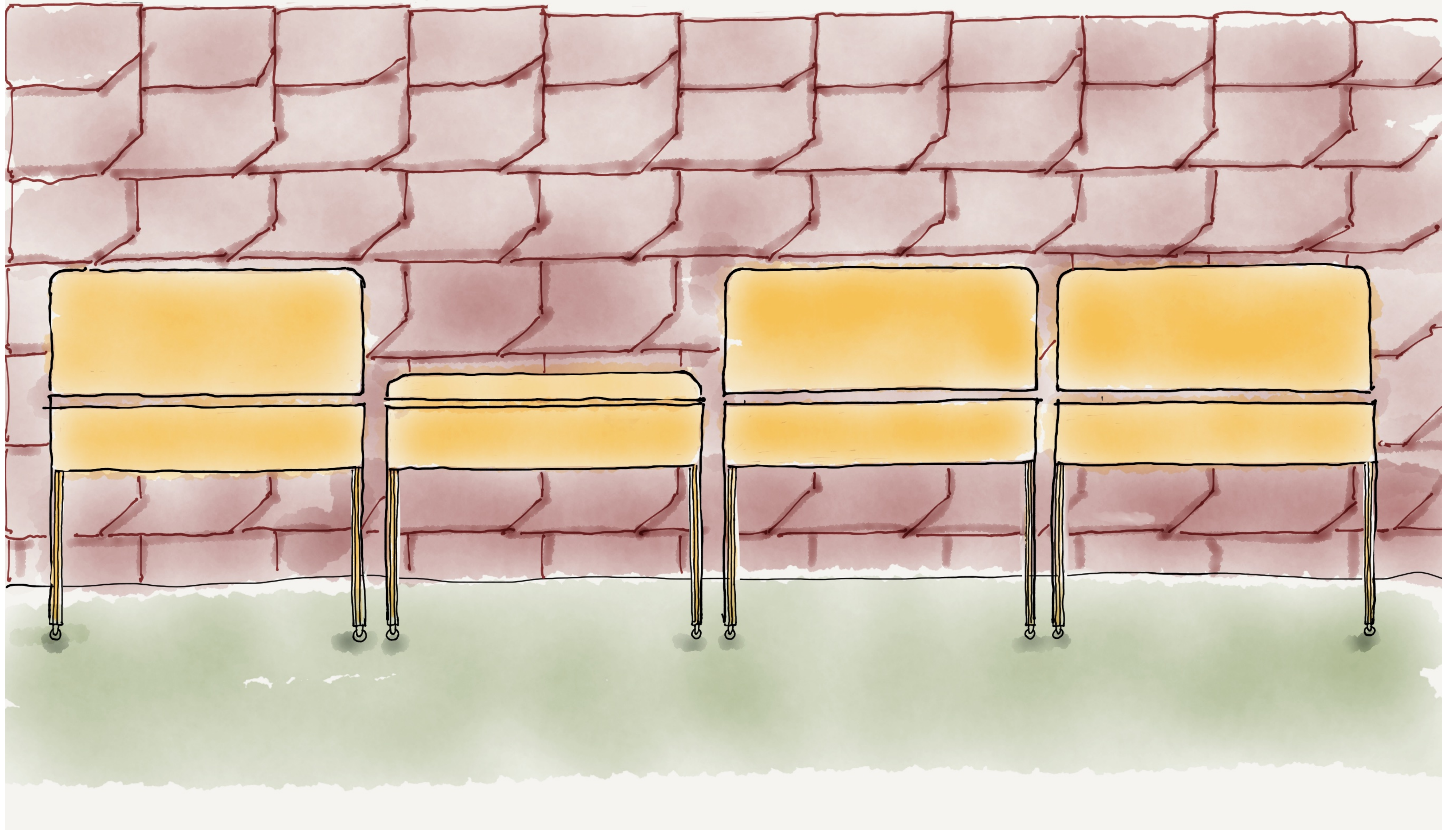

Slot Wall System

Vertical post option

- Brass, Steel and aluminium posts with vertical channels to hold various sheet material - Canvas concrete and clay panels
- Dark wood detailing
- Drop in metal sheet materials with integrated shelving options
- Easy to Create seasonal colour and texture changes - Eg bold stripes
- Hook rail system
- Curved wall option

VERTICAL POST SLOT SYSTEM

MULTI-PURPOSE | MULTI MATERIAL PANELS FOR COLOUR & TEXTURE

- HOOK RAIL SYSTEM
- MULTI SHELF SYSTEM
- GARMENT RAIL

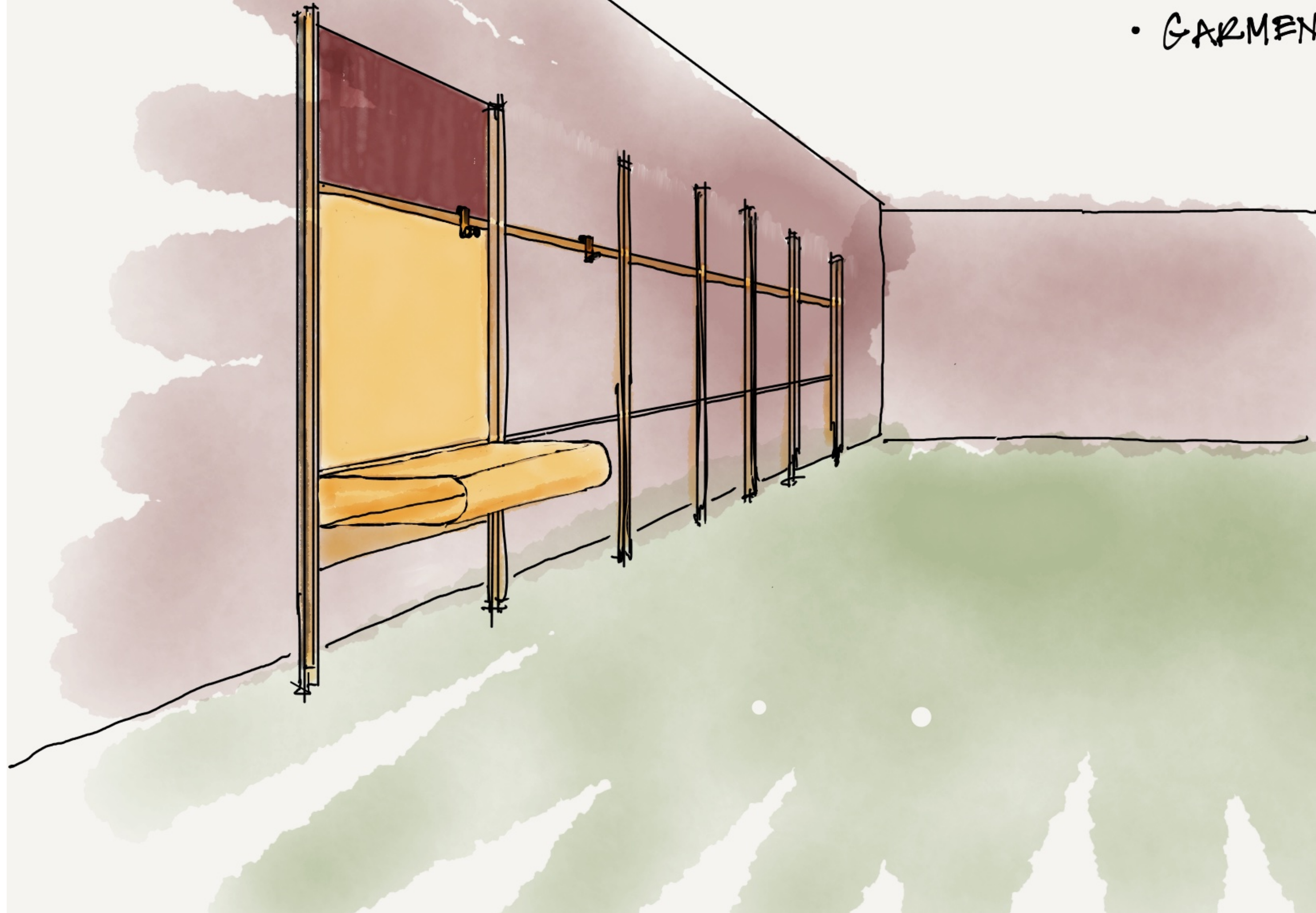

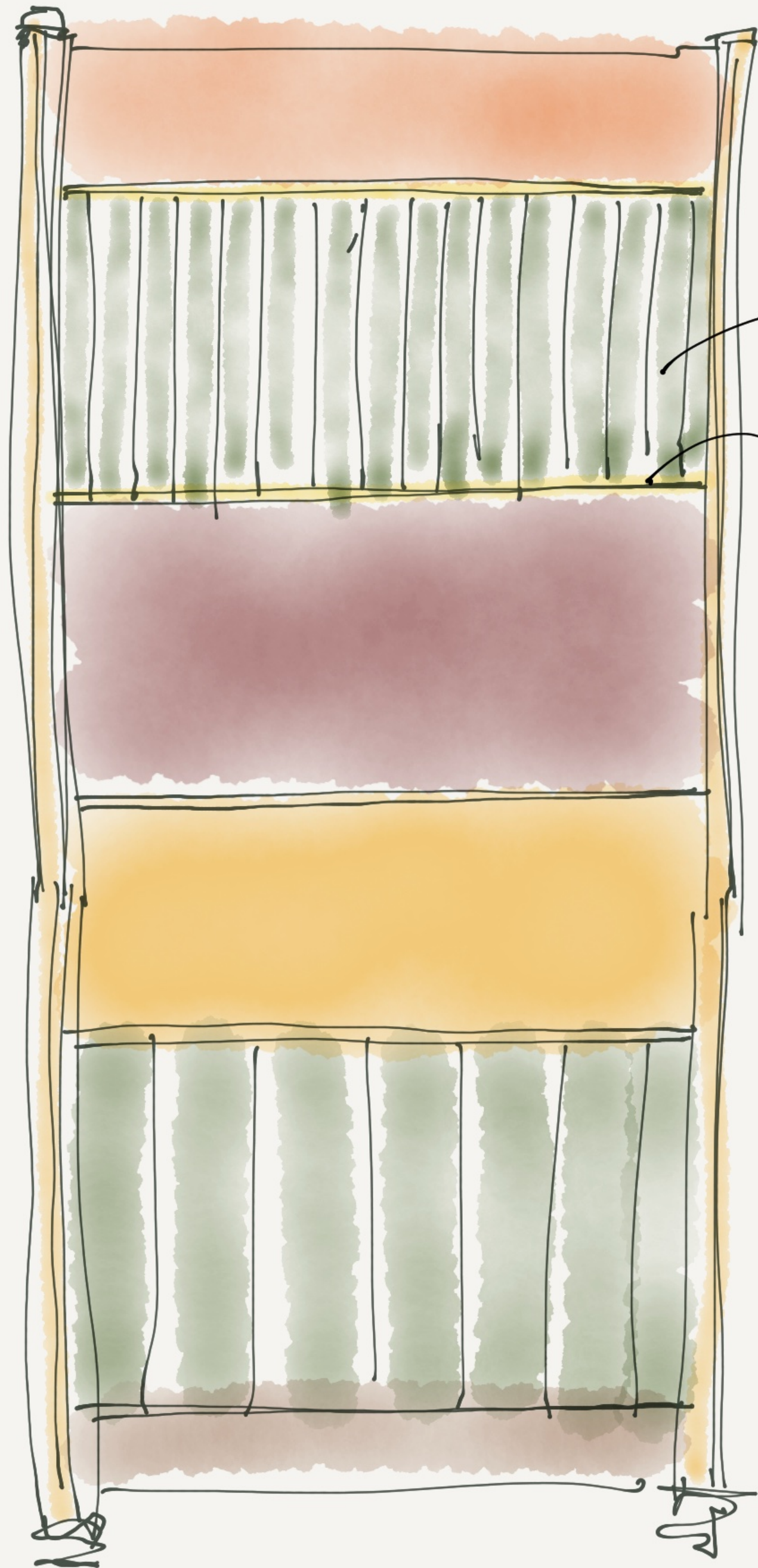

SLOT WALL
- WITH HORIZONTAL CHANNELS

VARIOUS PANEL OPTIONS | MATERIALS - TEXTURE | COLOUR BLOCKS

INDIVIDUAL VERTICAL TILES | CLAY | CONCRETE - TO FIT HORIZONTAL SLOTS CHANNEL

HORIZONTAL SLOT - CHANNEL

- BRASS
- STEEL
- ALUMINIUM
- WOOD
- CLAY - COLOUR PIGMENT
- GLASS - RIBBED
- WIRE GRID
- POWDER COATED
- CONCRETE - CANVAS

SLOT-VERTICAL POSTS. | MIXED MATERIAL
STRAIGHT OR CURVED?

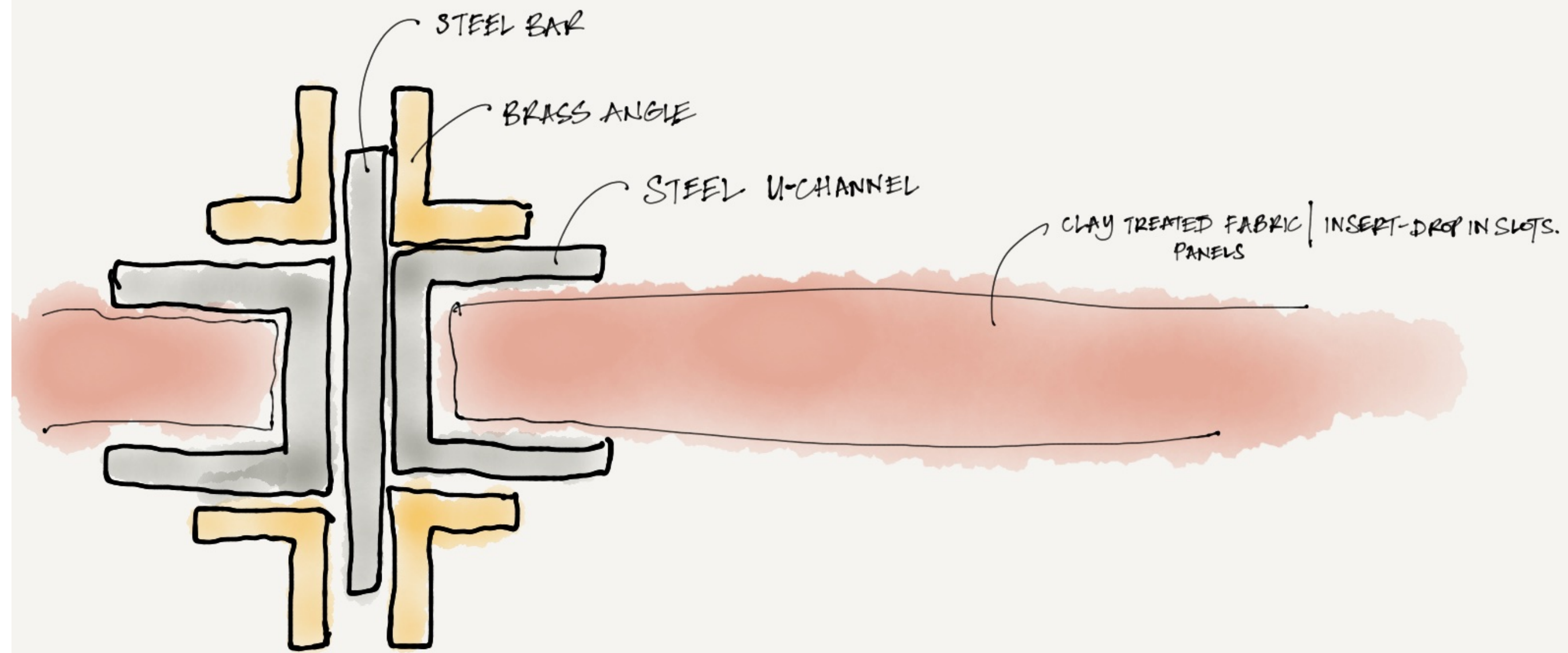

POST PROFILE



VERTICAL POLE SLOT SYSTEM

→ CURVED VERSION

- BRASS
- STEEL
- DARK WOOD

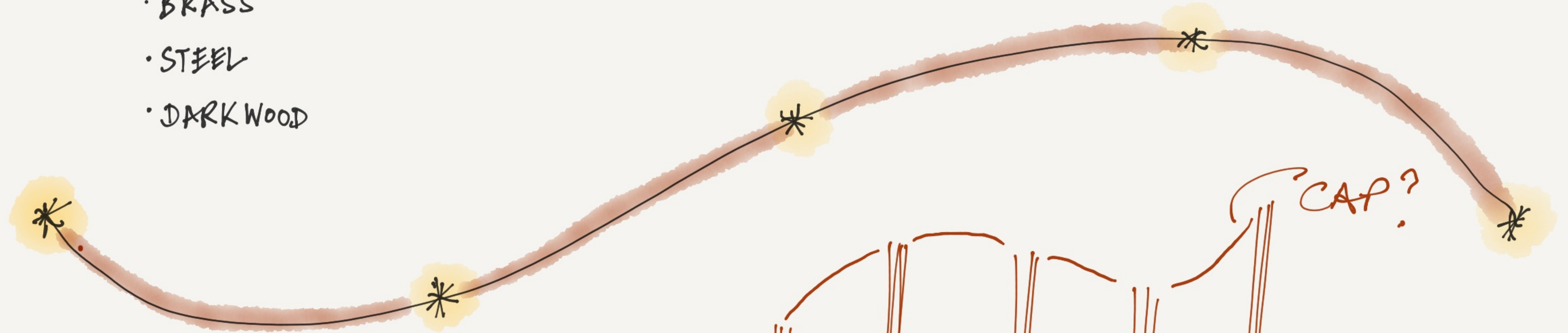

INSERT PANELS | CURVED
COLOUR PIGMENT TINTED

- CONCRETE | CLAY
- CANVAS-CONCRETE | LOW CARBON
- RECYCLED MATERIALS

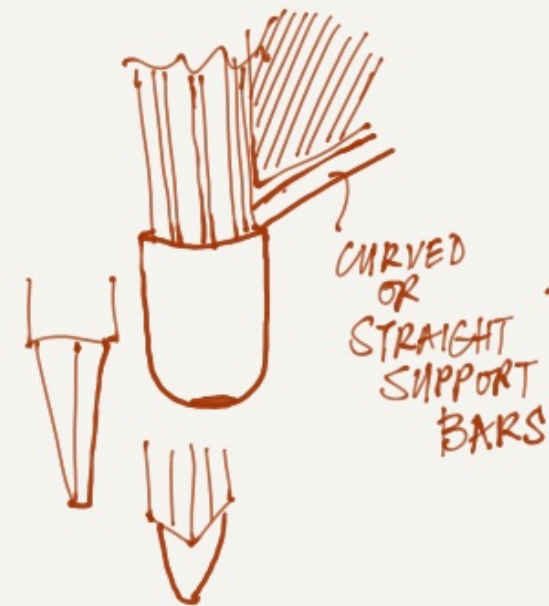

BASE FEET ??

DETAILING | VERTICAL POSTS | LEGS

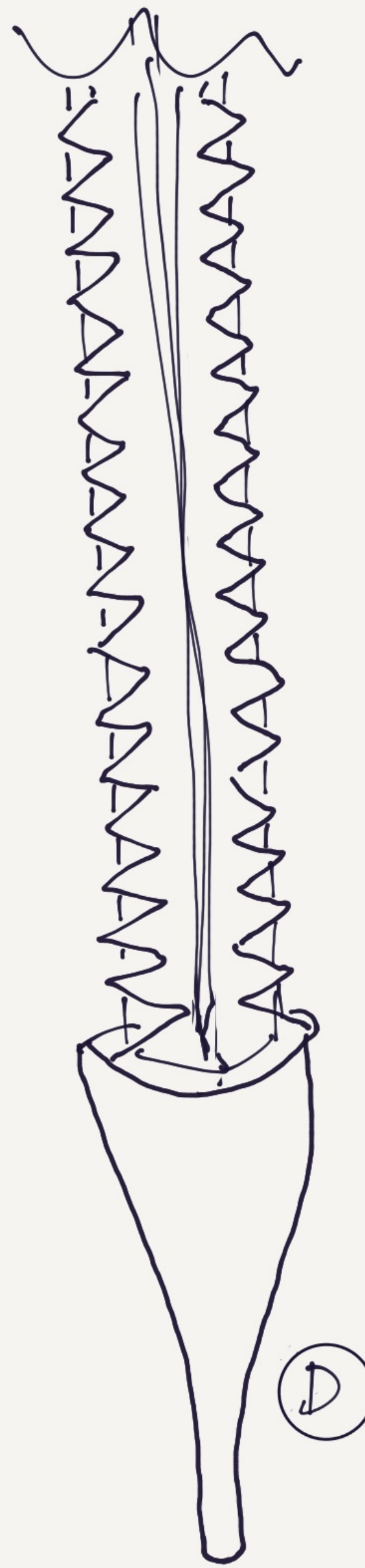
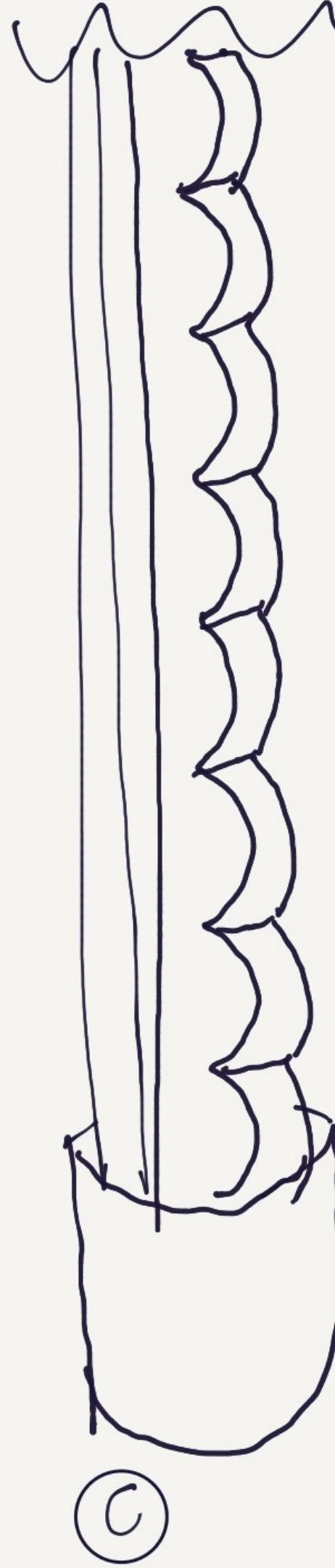
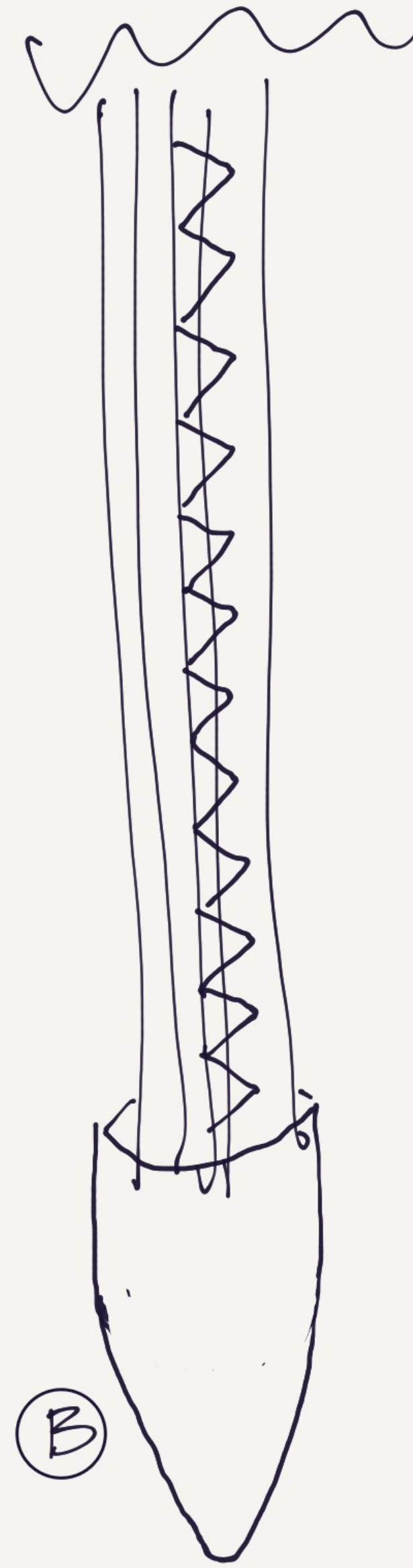
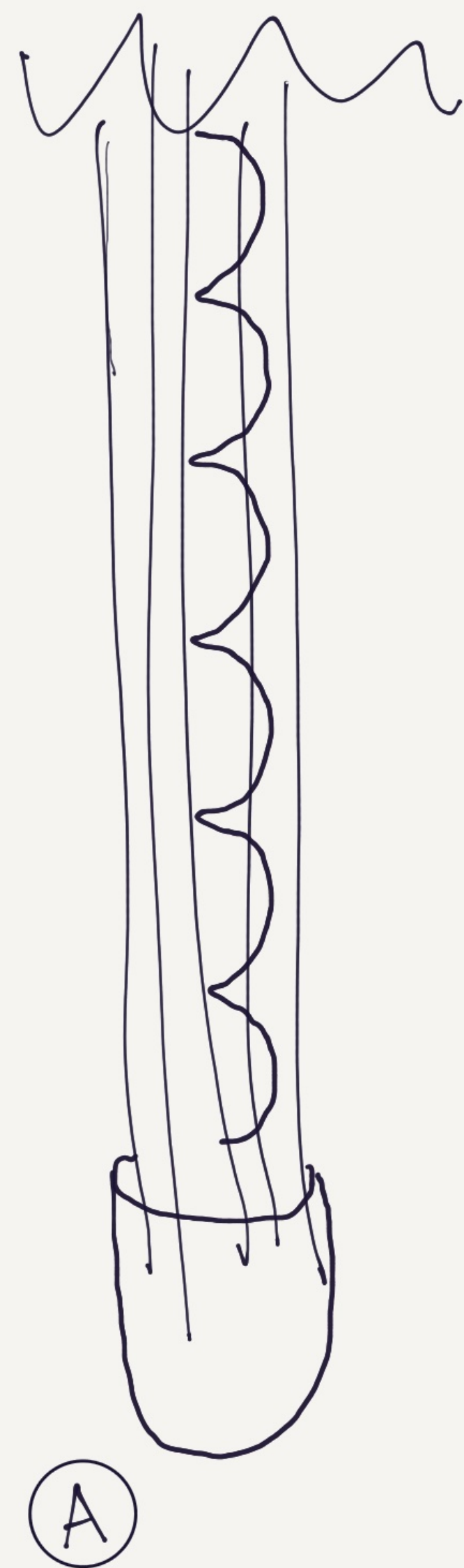

Ceiling | Lighting

Recessed Grid system

- Unistrut style system to suspend fittings and displays when required
- Octagonal concave domes with light fittings
- Recessed track lighting - low ambient and high accent

CEILING WITH RECESSED UNISTRUT STYLE GRID

- LIGHTING RECESSED DIMPLES | SPOTS + TRACK LIGHTING - WINDOW SCREENS

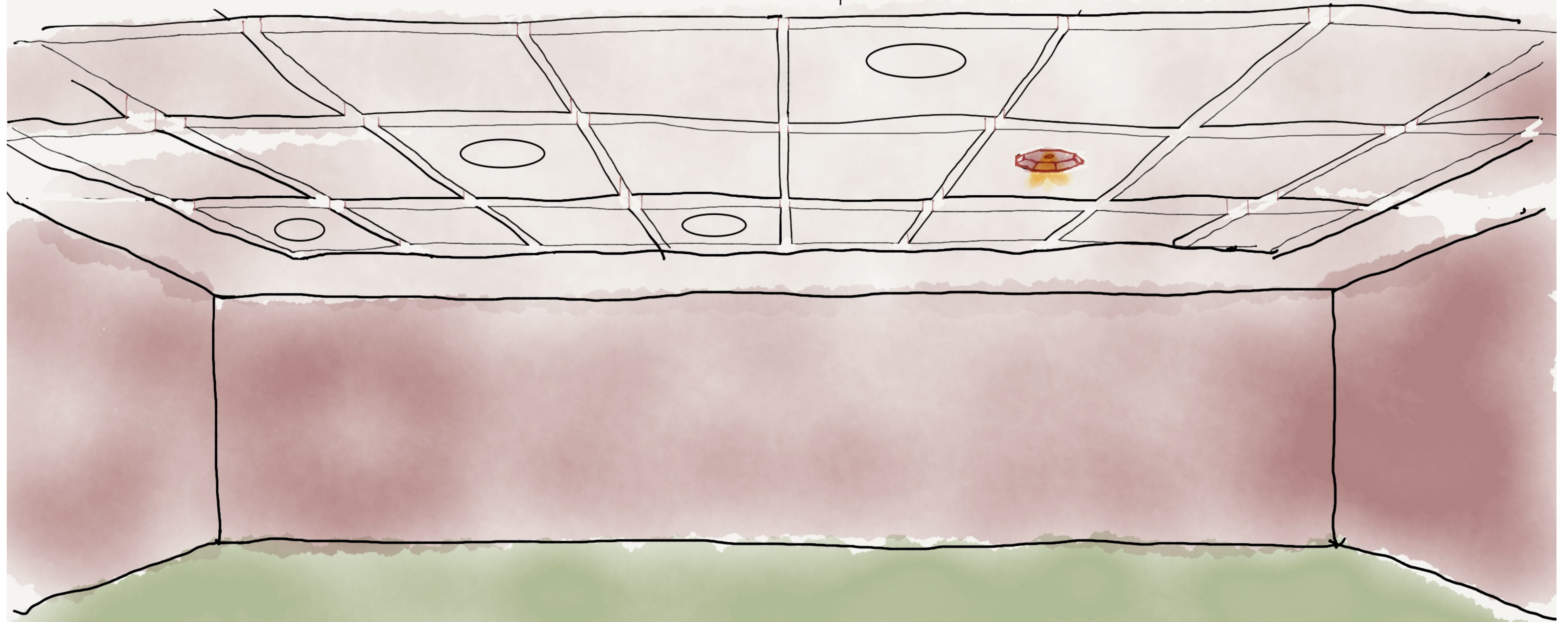

RJ Midfloor Units

Movable - Multi options

- Mirror end fascia panel
- Shelving
- Garment rail
- Hook rail
- Graphic panel lip

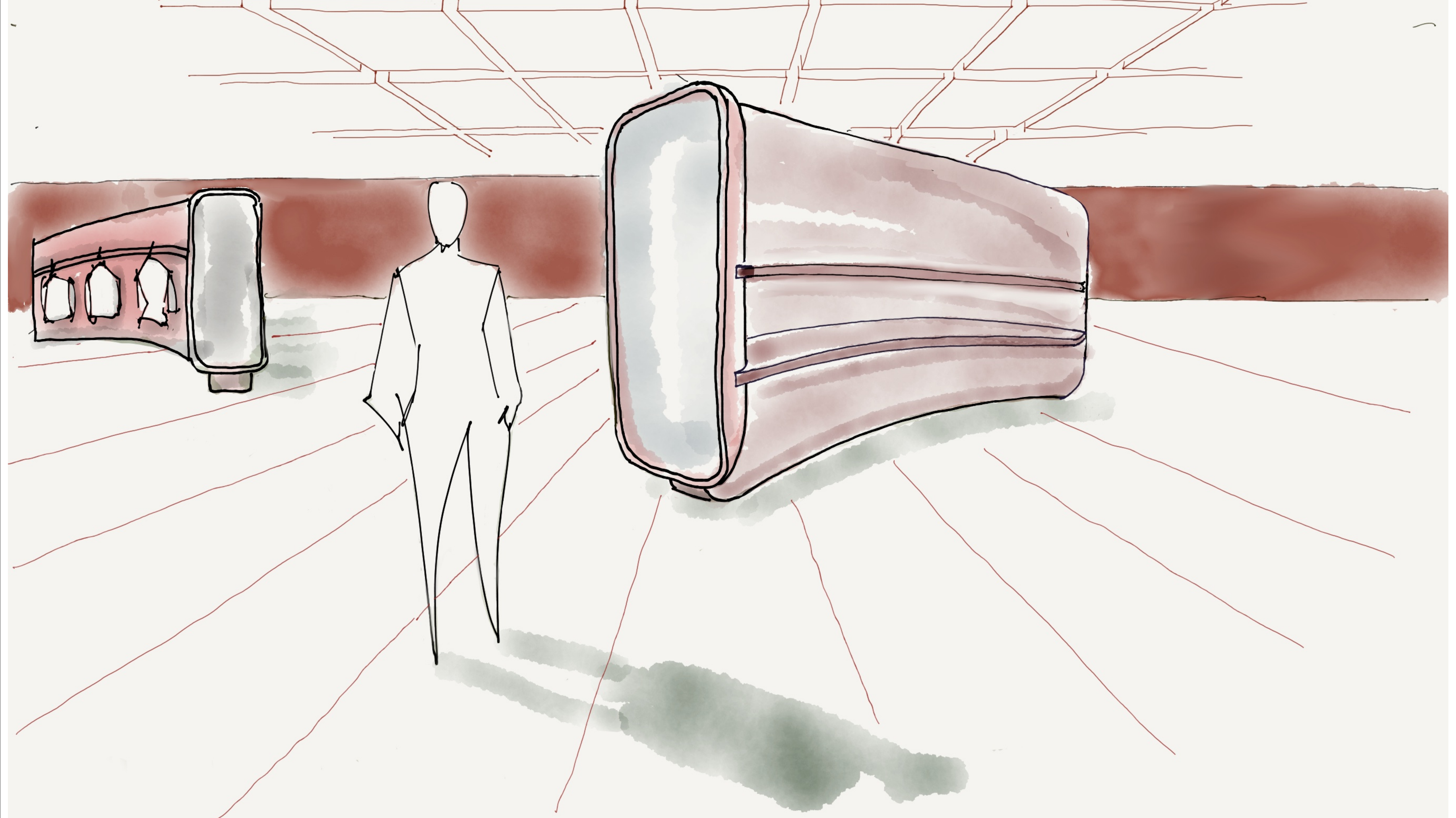

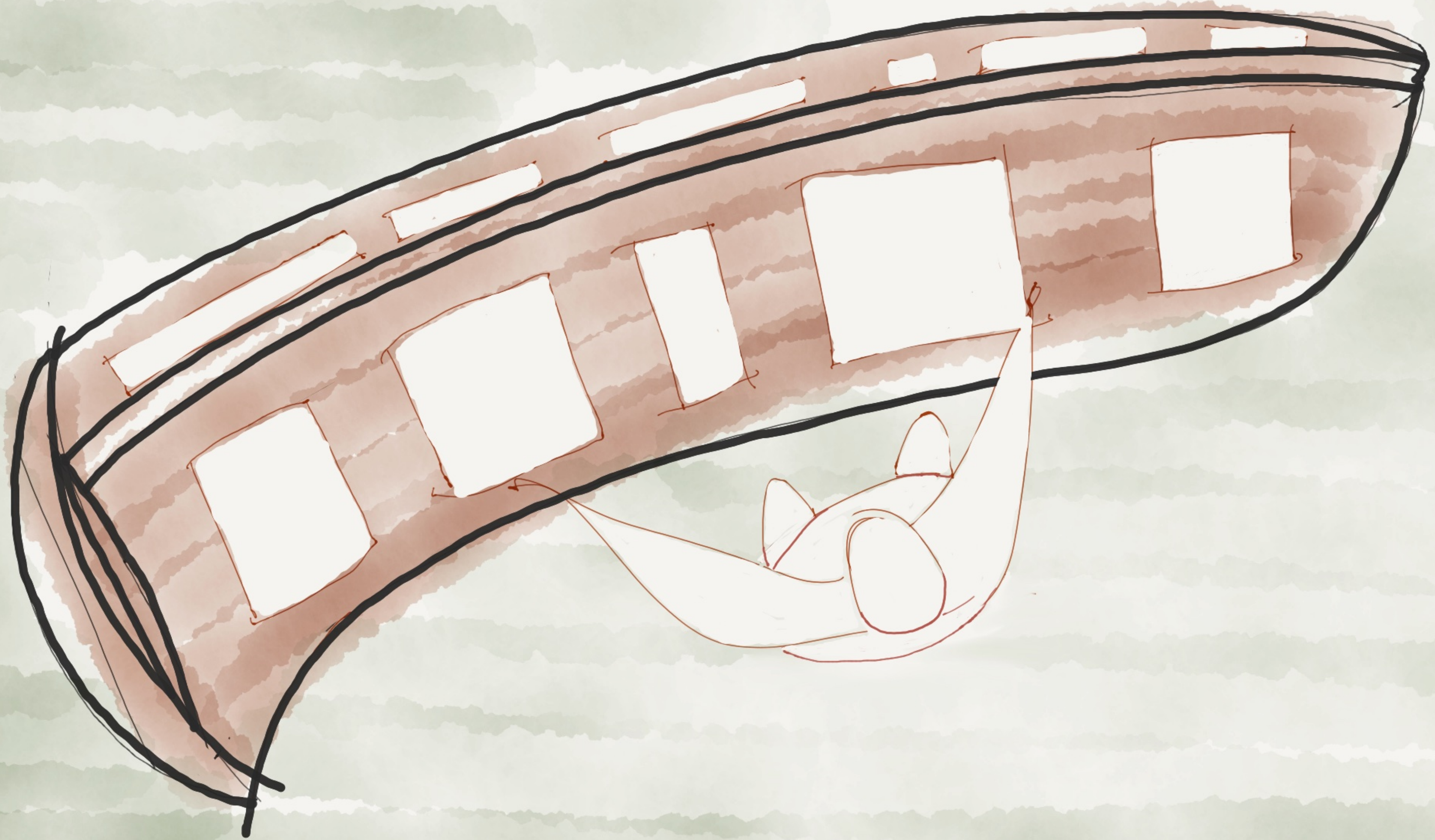

RJ MIDFLOOR UNITS | SIDE ELEVATION OPTIONS

SHELVING

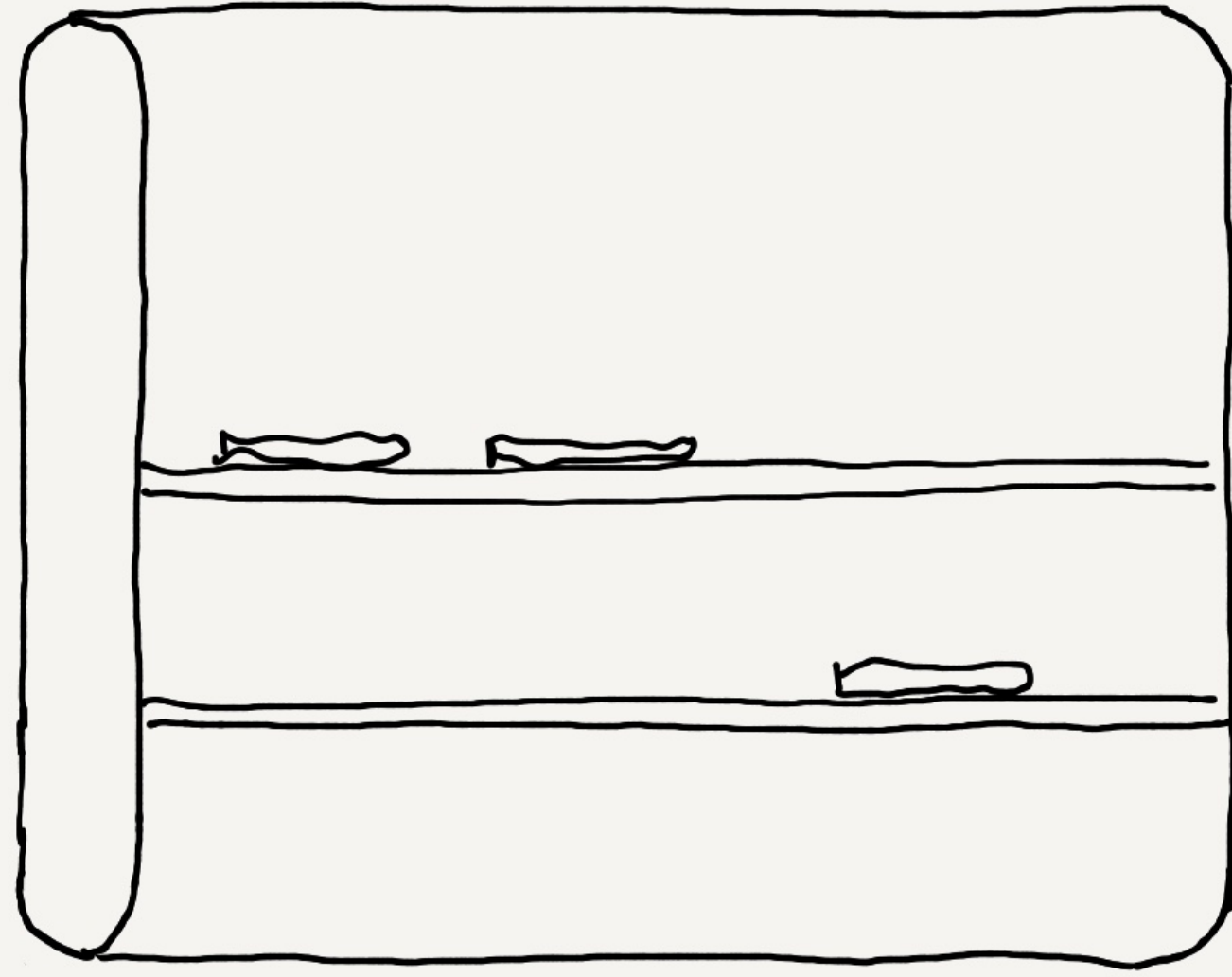

GRAPHIC PANELS | CAMPAIGNS

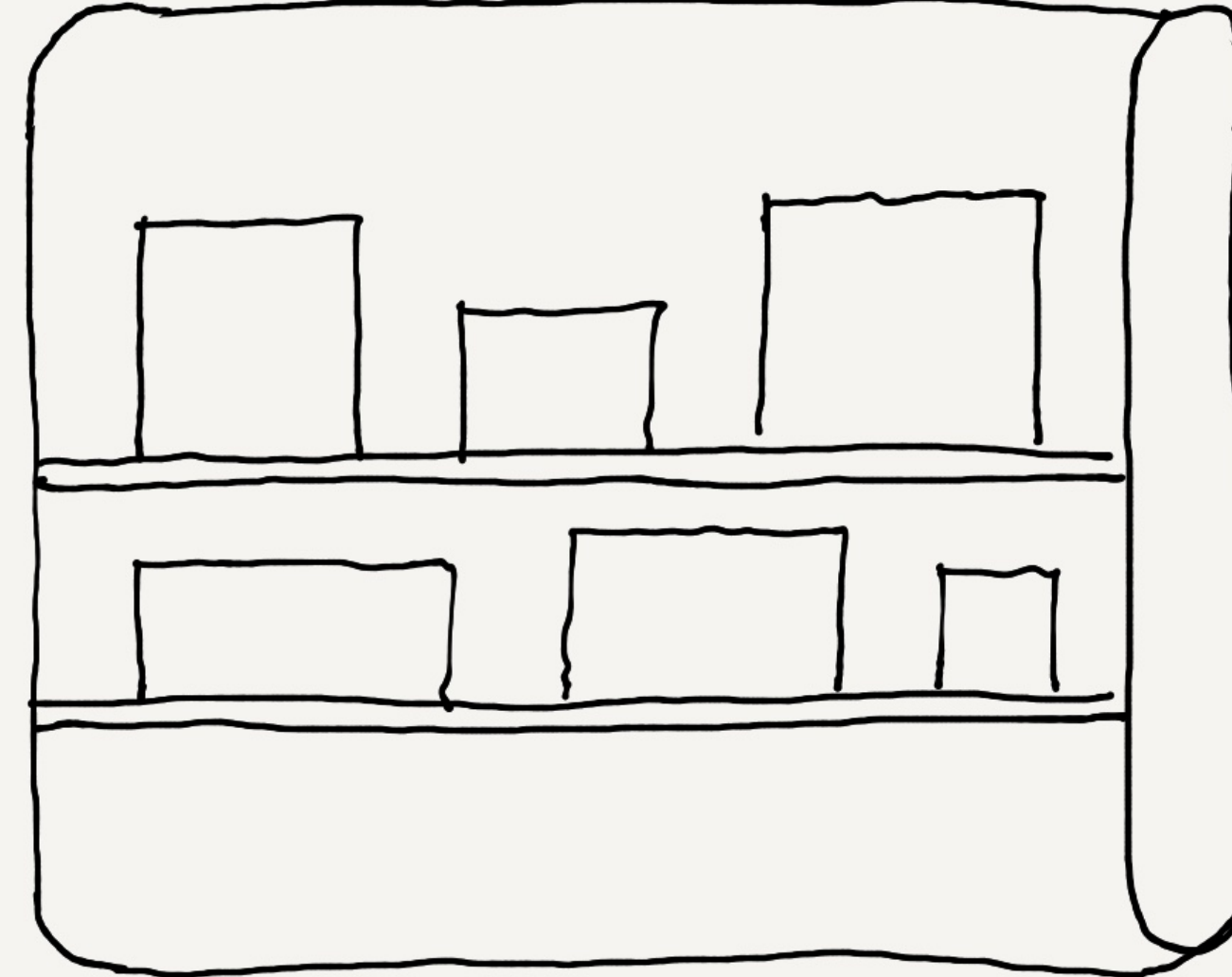

GARMENT RAIL

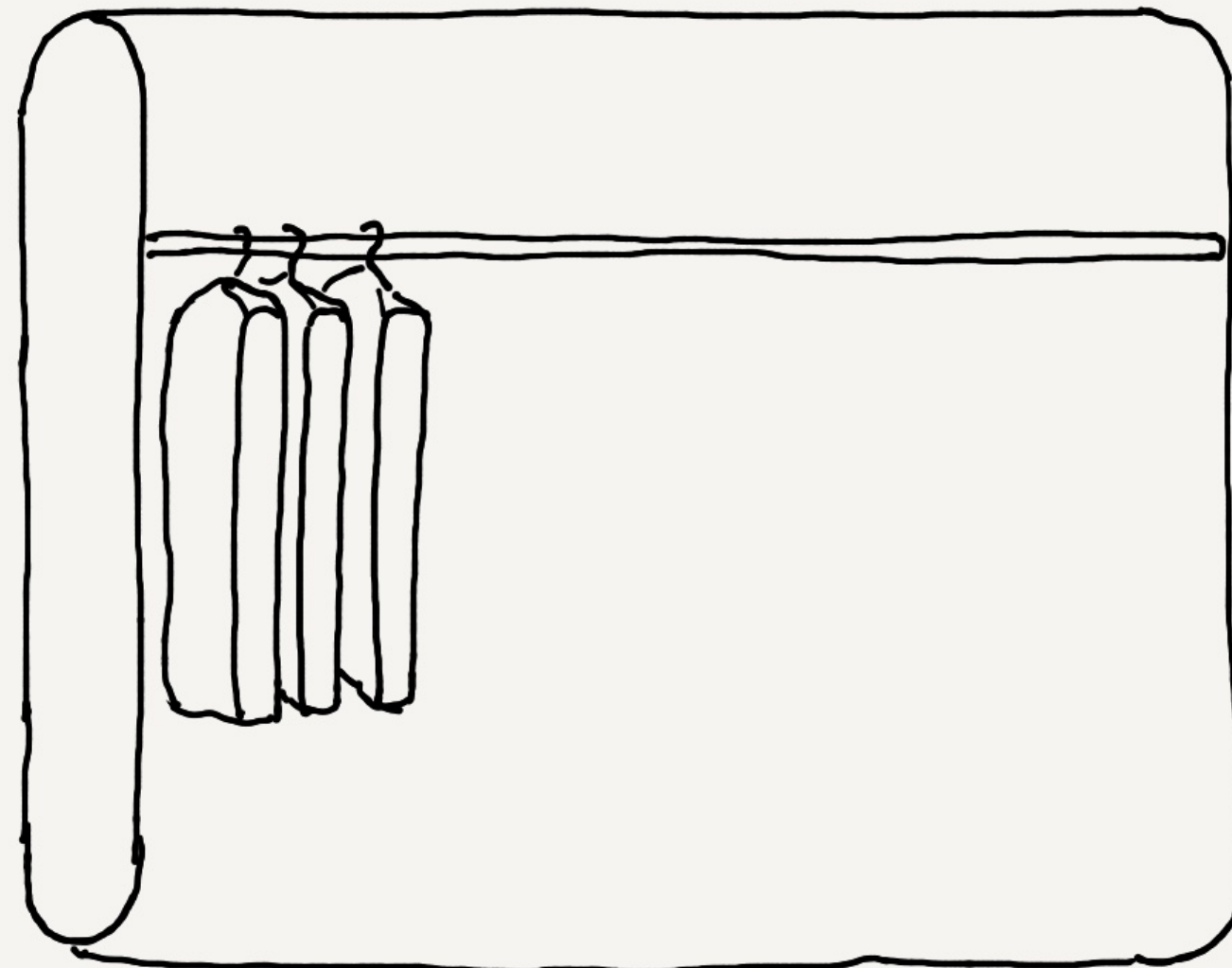

HOOK RAIL SYSTEM

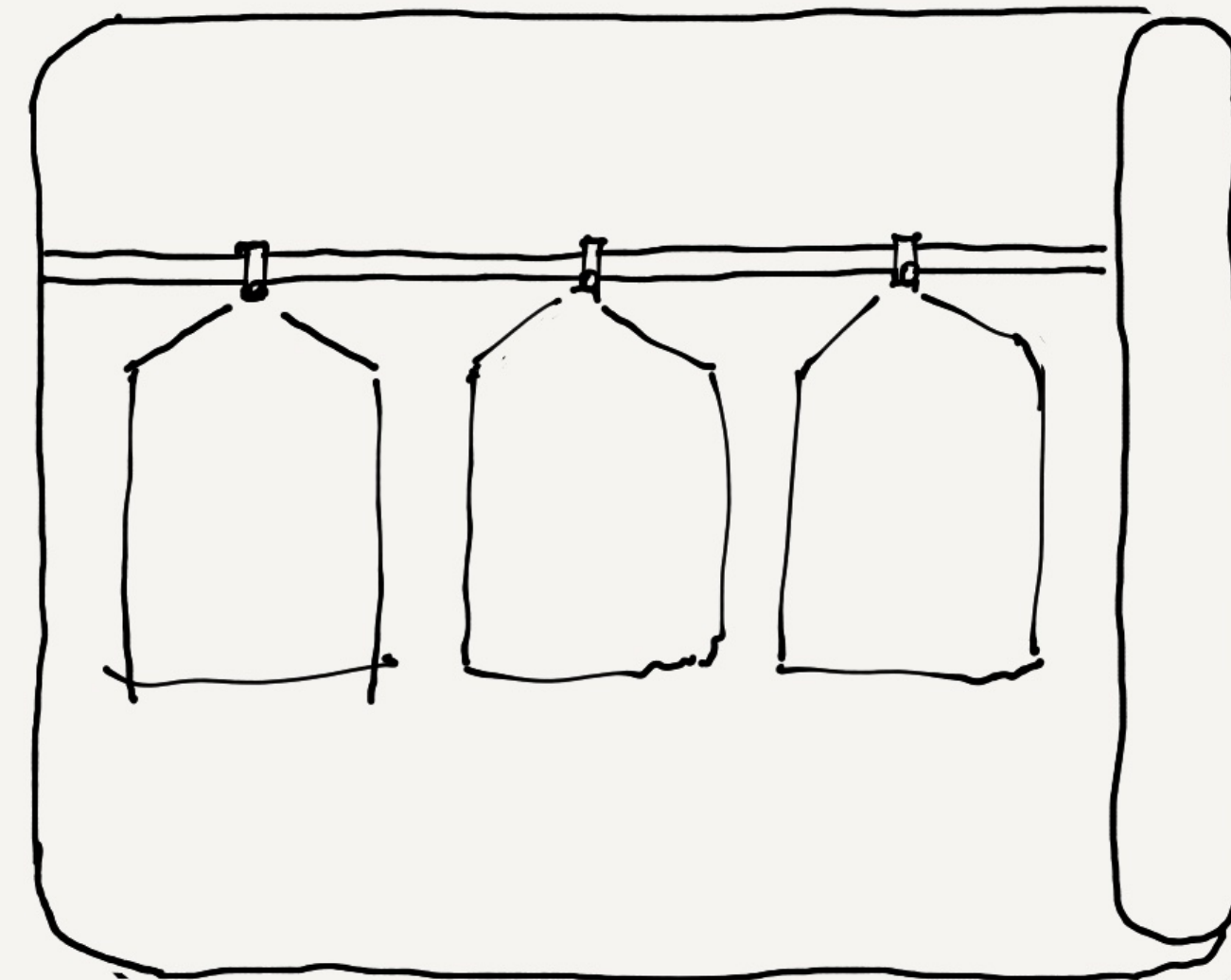

HL Midfloor | Perimeter Units

Mixed material with Lid top

- Brass, steel and aluminium - folded sheet panels
- Dark timber detailing - scallop/zigzag edge
- Wheels for easy movement

DISPLAY UNITS
WITH LID.

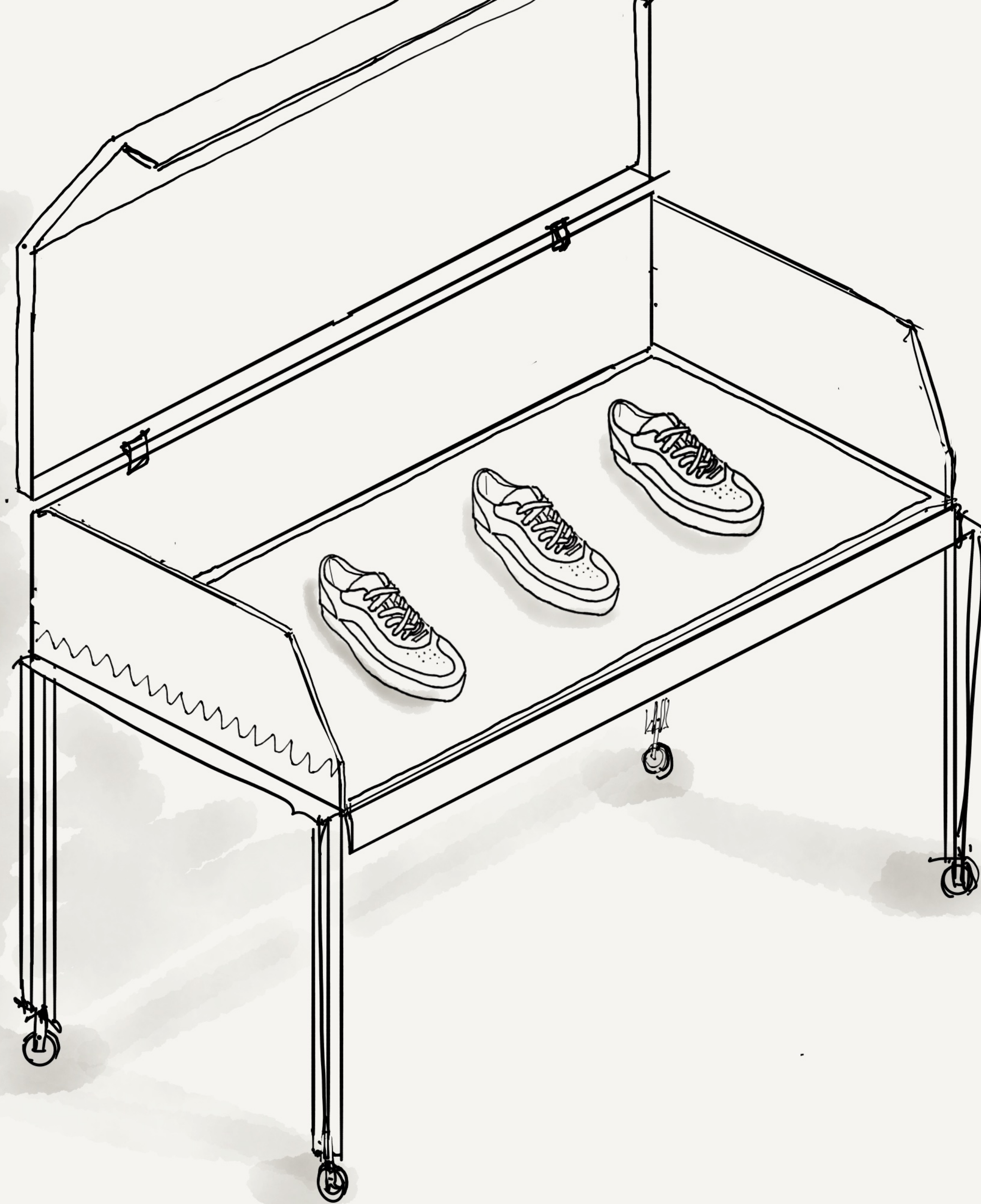

- BRASS
- ALUMINIUM
- STEEL
- WOOD
- DESIGN DETAIL
ZIGZAG|SCALLOP
- TRAVERTINE
DROP IN PANEL

PRODUCT UNITS

- WITH LIDS - TO BE USED OPEN & CLOSED

BRASS / CLAY PANELS / TIMBER
FRAMES - DROP IN
INSERTS

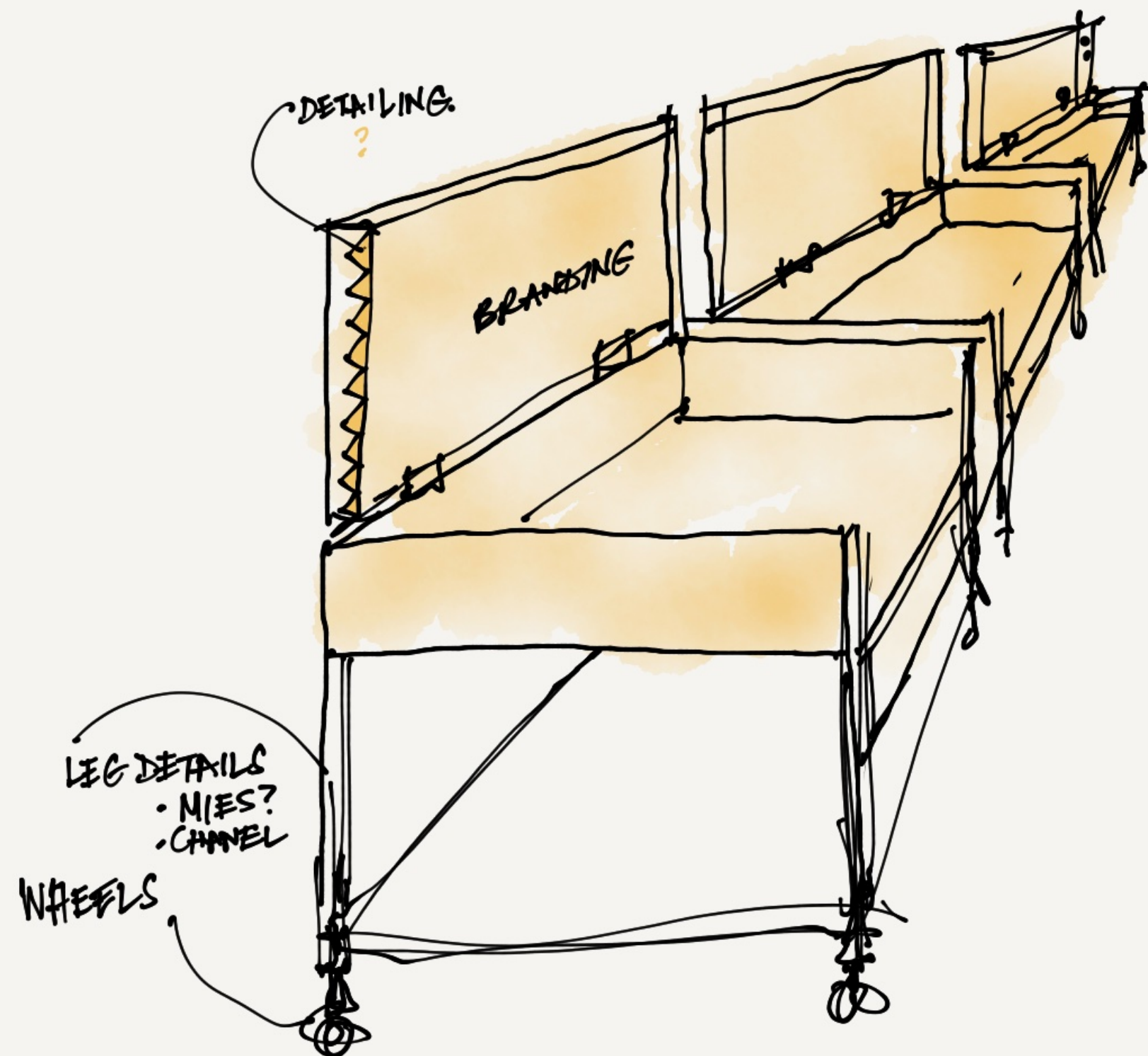

BACK TO BACK / MIDFLOOR.

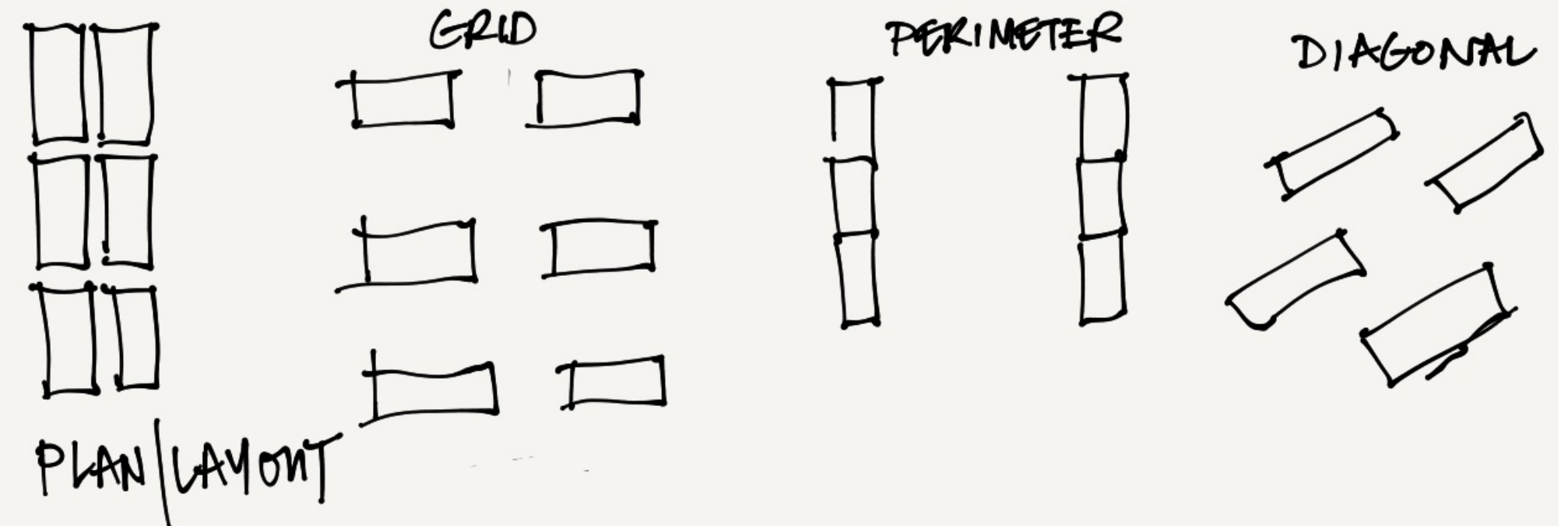

→ NUMEROUS CONFIGURATIONS

SHOE STANDS

- ADJUSTABLE HEIGHT
- BRASS | STEEL | WOOD
- TRAVERTINE | QUARTZ BASE WITH DETAILING

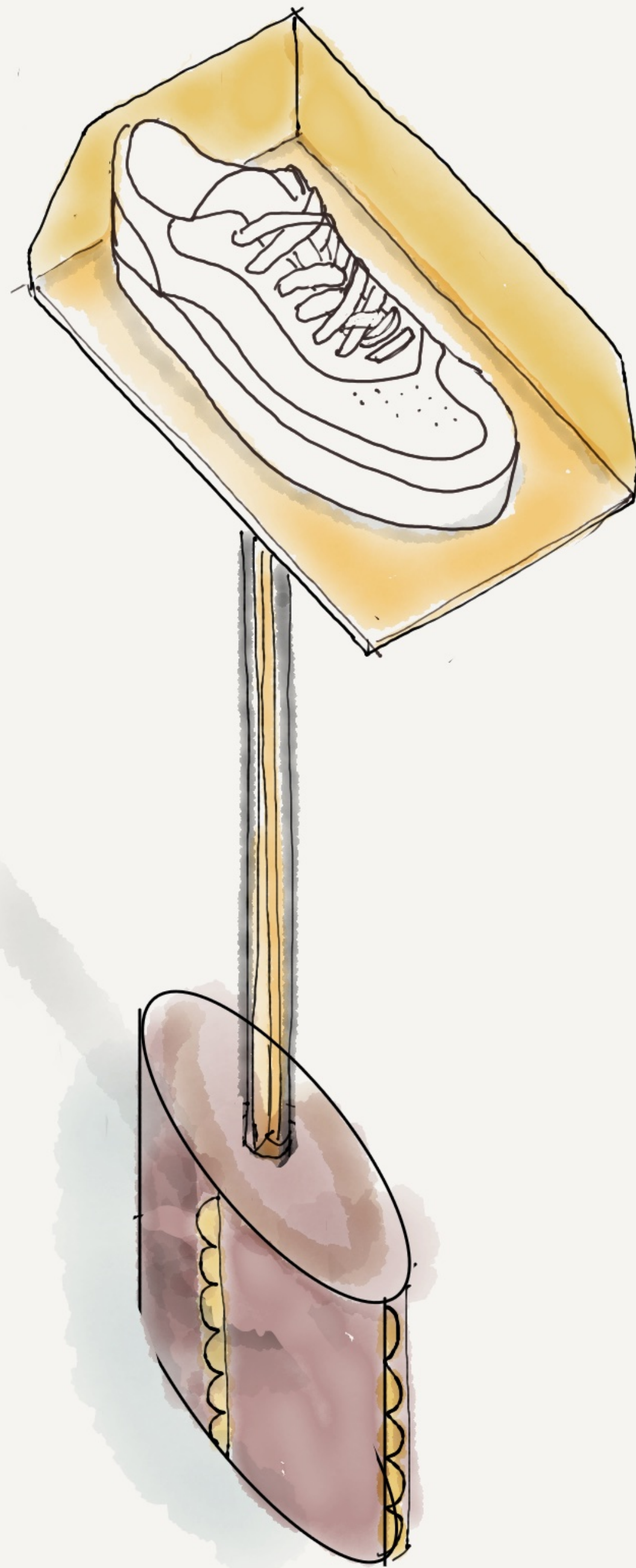

CHANGING ROOM POD

- MOVABLE/WHEELS

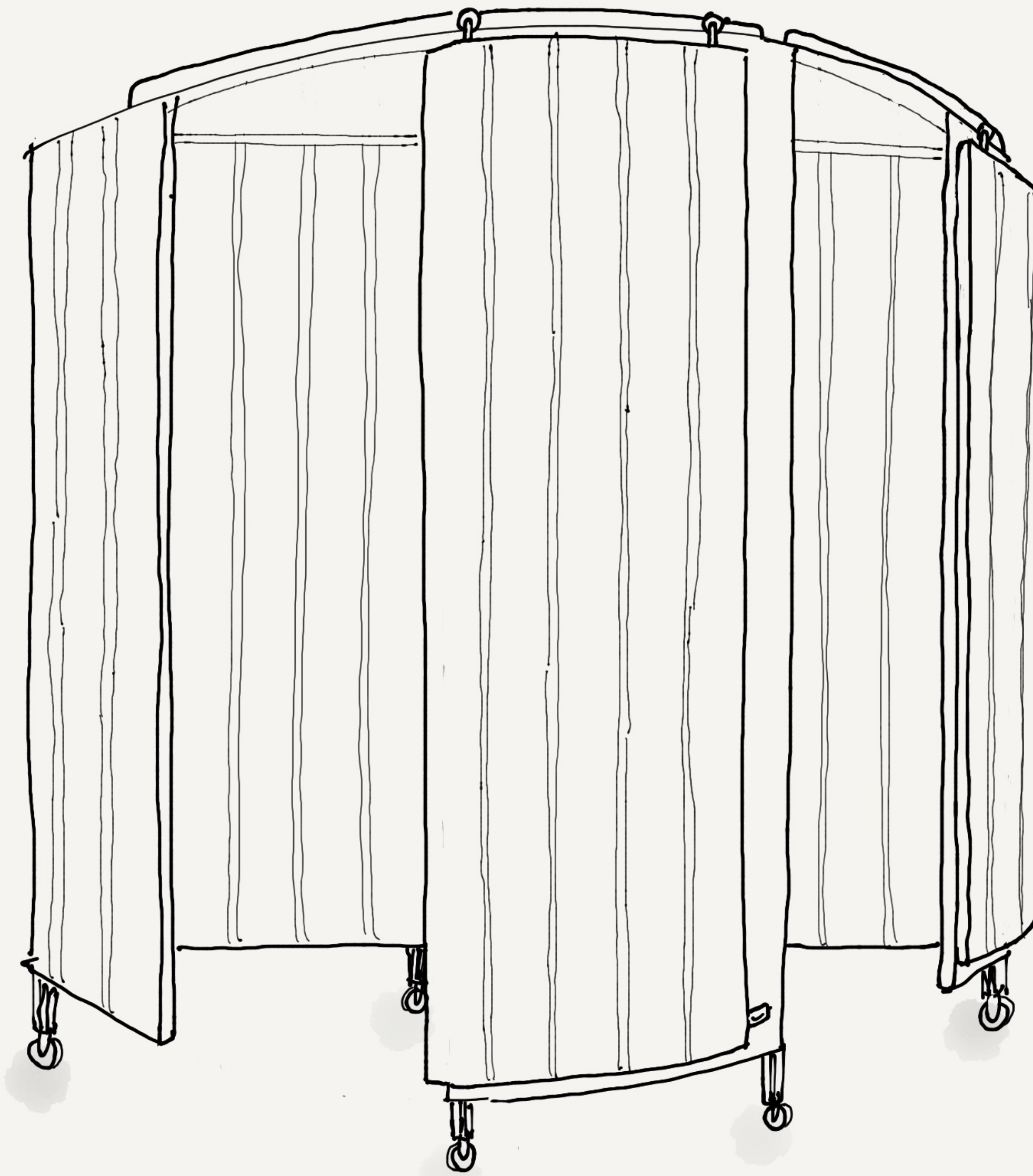
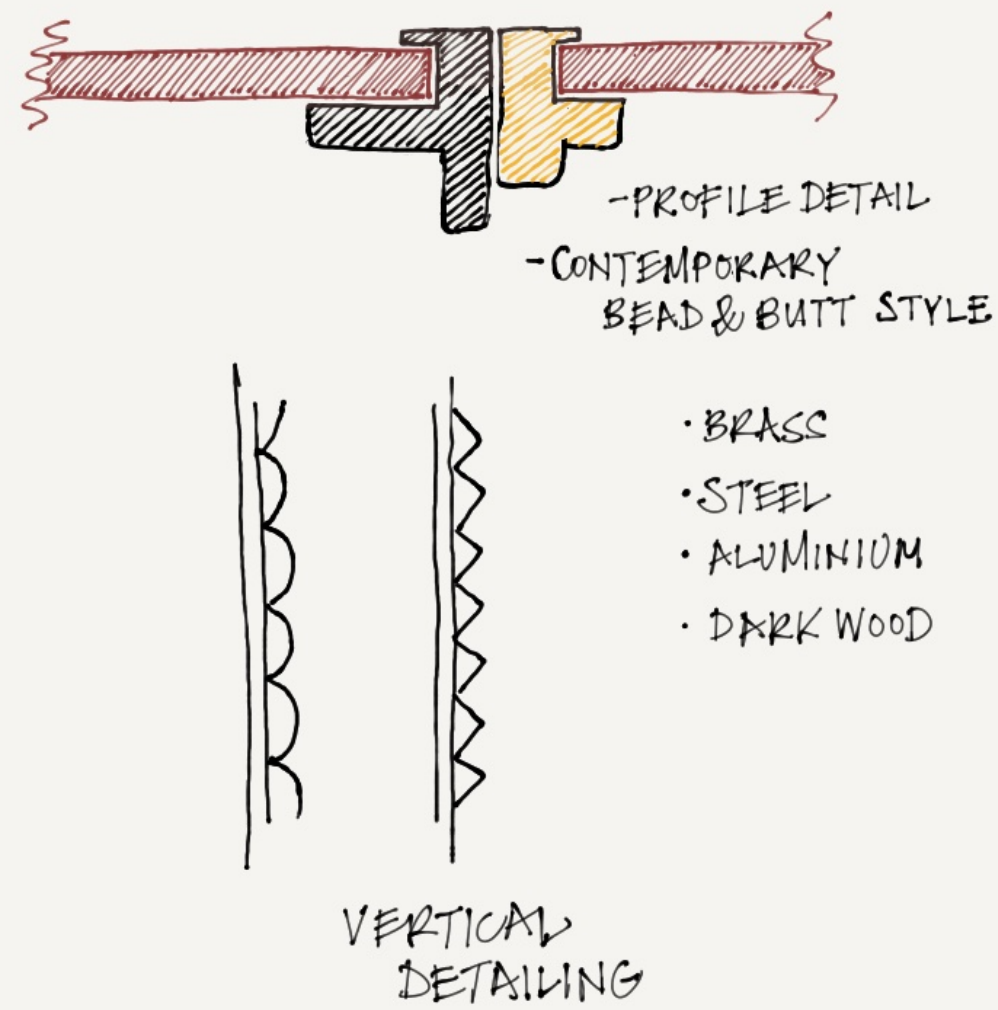

CHARLIE MCGUINNESS DESIGN - DEC'23

PRODUCT TRAYS

- WOOD | FOLDED SHEET METAL?
- WITH DETAILING

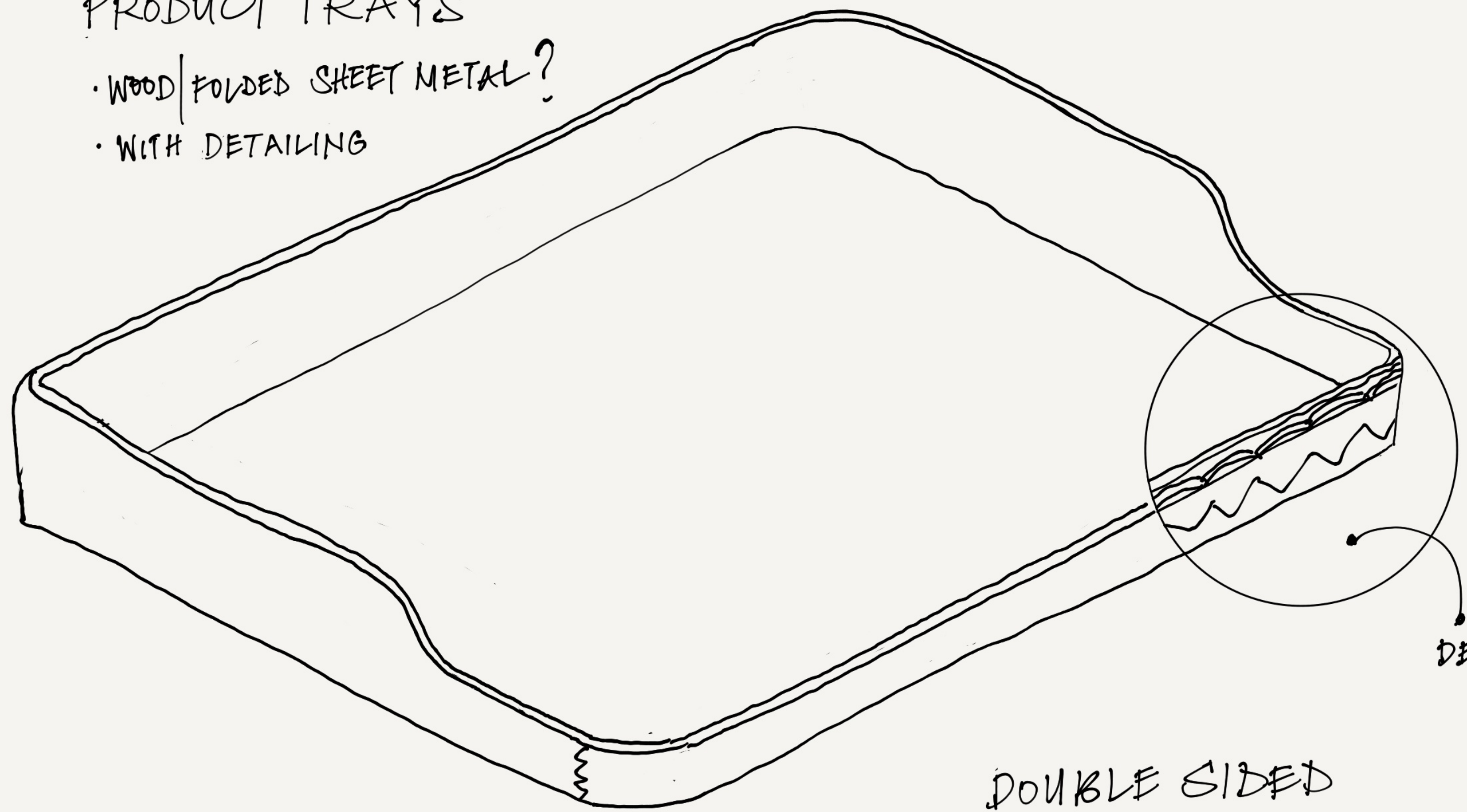

RADIUS
CORNERS

DOUBLE SIDED

- TRAY SIDE
- PLINTH SIDE

DETAILING
TBC

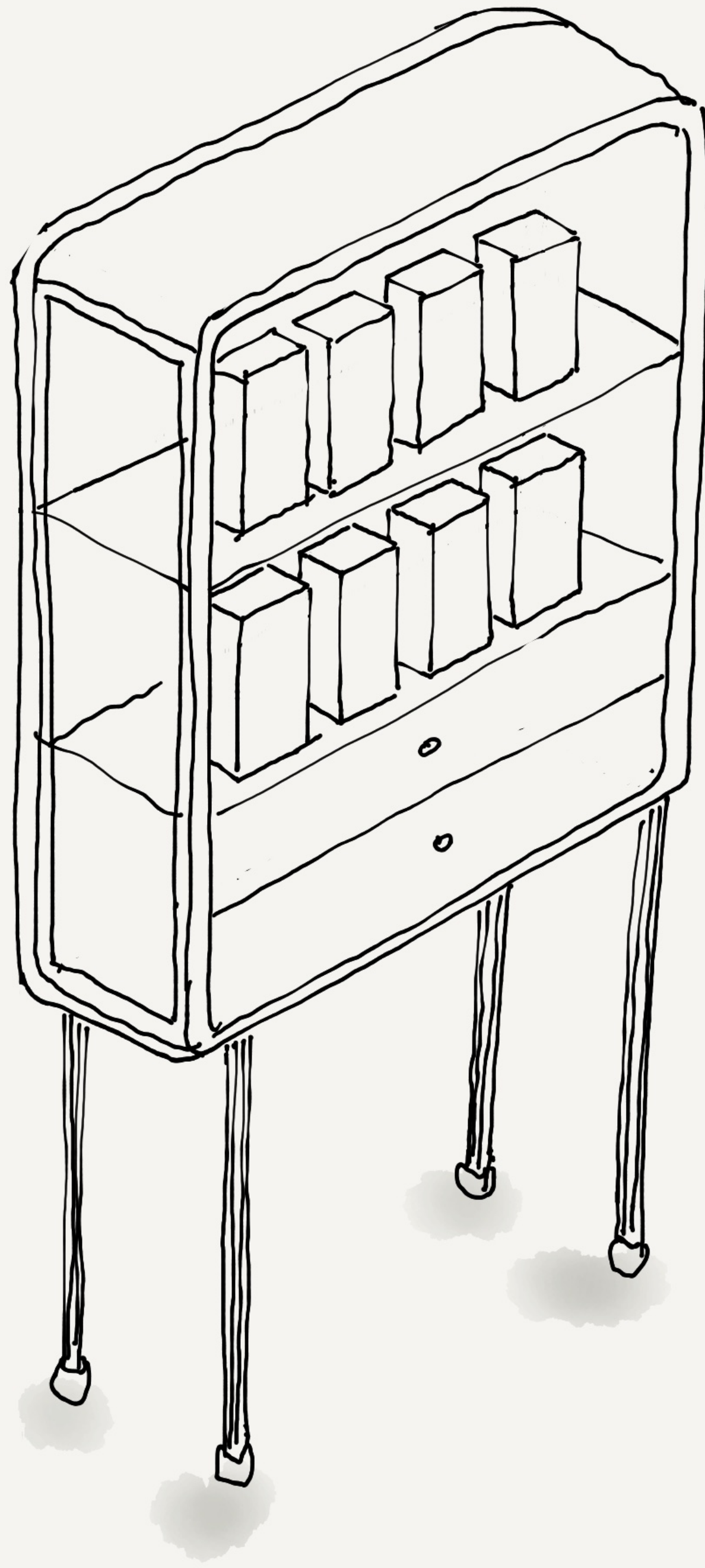

TALL
FRAGRANCE
CASE

LINKING TO VITRINE DESIGN